

Caxa power distribution box design





Caxa power distribution box design

How to Design an Electrical Power Distribution System

Learn how to design an electrical power distribution system step by step, covering load analysis, voltage selection, equipment choice, and safety



Power Distribution Systems

In order to design the best distribution system, the system design engineer must have information concerning the loads and a knowledge of the types of distribution systems that are applicable.

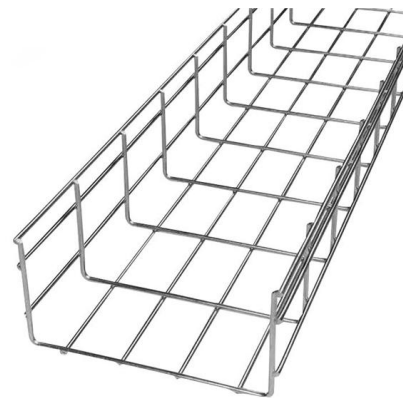

Efficient Power Distribution Boxes , Nijsha Enterprise

Nijsha Enterprise manufactures heavy-duty power distribution boxes for commercial & industrial use--modular, safe, and built for demanding environments.



Design of New-Type Power Distribution Cabinets

Explore innovative design strategies for HV/LV power distribution cabinets and boxes, focusing on safety, reliability, smart control, structural optimization, and

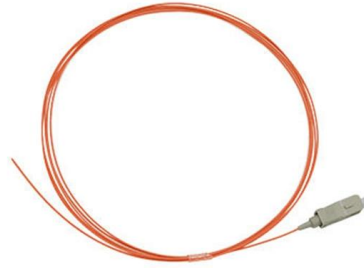

Cable Distribution Box Layout: 10 Industrial Strategies

Optimize your cable distribution box layout for safety and efficiency. Learn industrial best practices using Chuanli's IEC-standard outdoor and custom boxes.

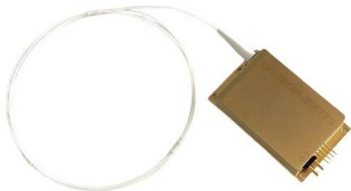

Custom Power Distribution Box Manufacturers , J& HW

Custom Power Distribution Box Reliable Partner of Power Distribution Box with 15 Years of Experience Submit your requirements or design draft to us, and we'll



Understanding Power Boxes: Essential Components for Efficient Power

The power box, a crucial component of electrical infrastructure, plays a significant role in China's rapid urbanization and industrial growth. Understanding its functionality and design is





Distribution Box Guide: Types, Components & Solutions

Understand distribution boxes (DB boxes) in 5 minutes. Learn about types, components, functions, and uses. Find the perfect DB box for your needs.

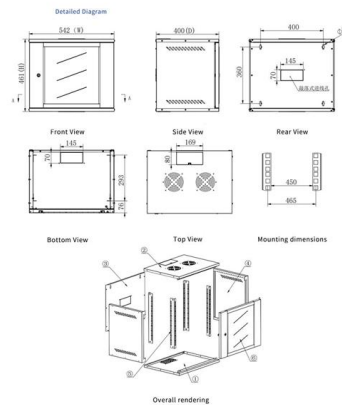

distribution

The GrabCAD Library offers millions of free CAD designs, CAD files, and 3D models. Join the GrabCAD Community today to gain access and download!

Distribution Boxes Types - The Complete Guide

The power distribution boxes deliver electricity from the main electrical main to other circuits. Several distribution boxes are designed for specific use in



Distribution Box Design - Techware

The distribution panel houses all critical components such as circuit breakers, earth leakage units, and timers, receiving input from a main feeding cable to distribute



Power Distribution Equipment

Each has its own unique standards and application guidelines, and one facet of good power system design is the knowledge of when to apply each type of equipment and the limitations of each type of



- IP65/IP55 OUTDOOR CABINET
- WATERPROOF OUTDOOR CABINET
- 42U/27U
- OUTDOOR BATTERY CABINET

Distribution Boxes Explained: Types, Functions, and

Learn about distribution boxes, their types, functions, and safety features to ensure efficient and secure electrical power distribution in any building.

PowerBox Factory

PowerBox factory offers a vast range of PDUs, distro boxes, racks, panels, adapters, cable extensions and splitters to safely manage power distribution, all designed

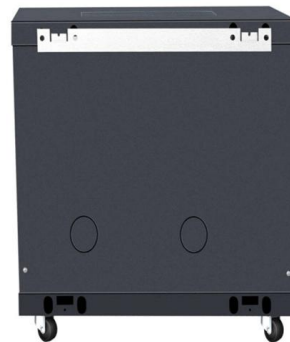

Complete Guide For Distribution Boxes Types

Distribution boxes, also known as electrical distribution boards or panels, are pivotal components in electrical systems, ensuring the safe and organized distribution of

PowerBox Factory



Power distribution boxes, racks, splitters, adapters and cables. Custom-made and certified PDUs, easy to move and stack up.



Power Distribution Boxes

Custom power distribution boxes are engineered to meet your specific power management needs. Our boxes feature modular designs with flexible input/output

Basics of power system design

When considering the design of an electrical distribution system for a given customer and facility, the electrical engineer must consider alternate design approaches that best fit the following

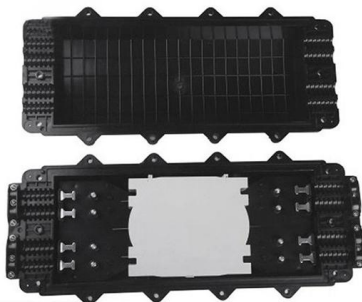

forum oncad.pl

Hier sollte eine Beschreibung angezeigt werden, diese Seite lässt dies jedoch nicht zu.



MNS® Low Voltage Distribution Board and Power Cabinet

In designing the distribution board and power cabinet, ABB drew upon its wealth of experience with low-voltage switchgear and placed a strong emphasis on the product's ease of installation, operations,



What is a Distribution Box? - A Comprehensive Guide

A distribution box organizes and controls power flow, ensuring safety and efficiency in electrical systems.

Explore Power Distribution Box Types and Functions

Power distribution boxes are used in commercial and residential buildings and are part of the electrical system, also known as switchboards.

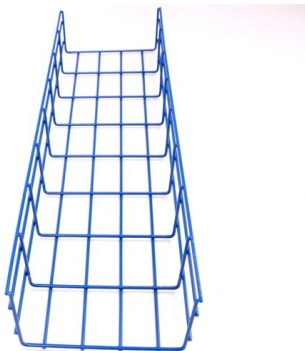

How to Choose a House Distribution Box , CHINT global

A well-chosen distribution box ensures the safety and efficiency of your household electrical system. This article guides you through selecting a



Power Distribution Equipment

Introduction Power Distribution Equipment is a term generally used to describe any apparatus used for the generation, transmission, distribution, or control of electrical energy. This section concentrates



High-voltage power distribution box design resources , TI

View the TI High-voltage power distribution box block diagram, product recommendations, reference designs and start designing.

Contact Us

For datasheets, pricing, or custom high-speed optical interconnect solutions, please visit:
<https://syropy.com.pl>