

Direct Sales of North Korean Molded Cable Trays

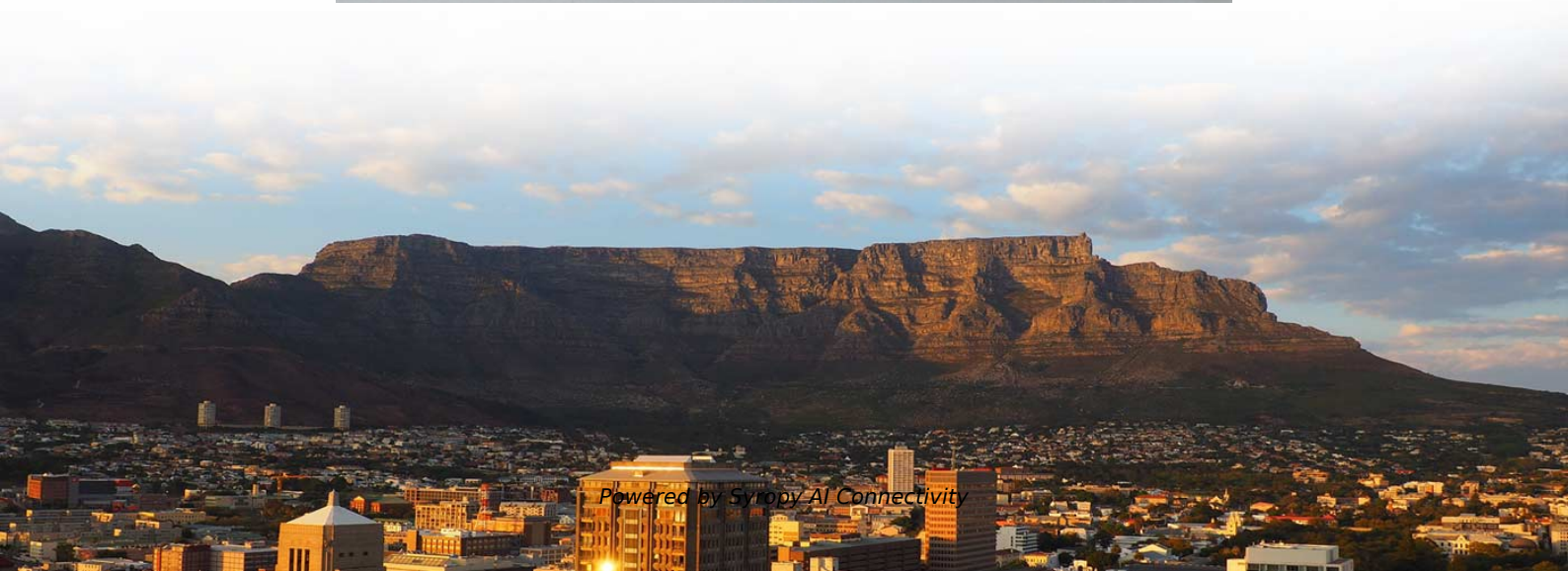



Direct Sales of North Korean Molded Cable Trays



South Korea Industrial and Commercial Cable Trays and

The analysis is structured to be adaptable to any South Korea Industrial and Commercial Cable Trays and Ladders Market while providing actionable, region-specific insights. North America

South Korea Metal Cable Trays Market Technology, Key

? Download Sample ? Get Special Discount South Korea Metal Cable Trays Market Size, Strategic Opportunities & Forecast (2026-2033) Market size



Home

ApexTray is a China Cable Tray Manufacturer and Supplier, good at one-stop cable tray systems, tray CAD design and etc. Contact us for free cable tray samples!



TaeHwa eng Co., LTD

TaeHwa eng Co., LTD - Korea supplier of cable tray, cableduct, floorduct, system box

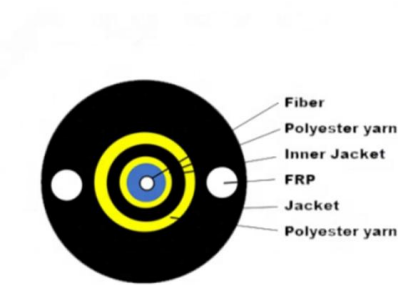

Cable Tray Manufacturer, Galvanized Cable Tray, Sprayed Plastic Cable

TONGZHOU MACHINERY (CABLE TRAY) FACTORY is a manufacturer with a daily output of more than 40,000 meters and an annual output value of more than 60 million dollars, specializing in the

South Korea Wire Cable Tray Systems, Korean Wire Cable Tray

Made in South Korea Wire Cable Tray Systems Directory - Offering Wholesale Korean Wire Cable Tray Systems from South Korea Wire Cable Tray Systems Manufacturers, Suppliers and Distributors at



Top 10 Cable Trays Manufacturers And Suppliers , B2B

This list of top 10 online B2B marketplaces and manufacturers will lead you to find your perfect cable trays based on your business requirements.



Cable Trays and Fittings

Cable trays consist of rigid components like supports, connectors, and fittings made of either certain steel alloys or aluminum materials. The right cable trays and



Cable Trays Market in South Korea , Report

The South Korean cable trays market is a critical component of the nation's advanced industrial and technological infrastructure. Characterized by high demand from the construction, manufacturing,

Cable Tray Market Size & Share Report, 2024 - 2032

Cable Tray Market Size The global cable tray market size was valued at USD 4.2 Billion in 2023 and is estimated to grow at a CAGR of over 6.8% from 2024 to

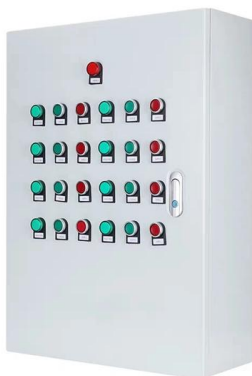
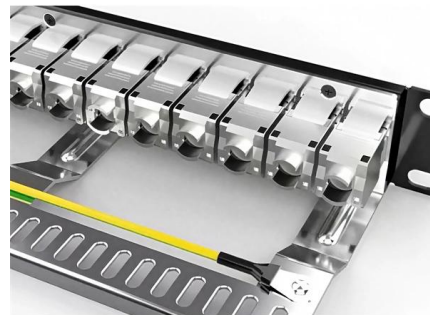

Cable Trays Market Size, Share & Growth Trend Report

The global cable trays market stood at USD 6.37 Billion in 2025 and may hit USD 17.60 Billion by 2035, with a CAGR of 10.70%.



Cable Tray Market Size, Share, Industry Report 2035

The cable tray market consists of sales of basket cable trays, power cables, and control cables. Values in this market are 'factory gate' values, that is the value of



Cable Tray In South Korea

As one of the best Cable Tray Manufacturers in South Korea, we are trusted by people not only within the boundaries but even beyond that. Our custom-based products are able to match up your distinct

Cable Tray Market Size, Share, Industry Report 2035

Major trends in the forecast period include growing deployment of modular cable management systems, rising demand for corrosion-resistant cable trays,



Cable Tray Systems

Our cable tray systems securely hold and protect cables and come in many models and sizes, solid bottom and ventilated.



Cable trays, electric Companies in South Korea , Find Cable trays

Cable tray, bolt, plus hanger #Company introduction Seoyoung Industrial Co., Ltd. was established in 2006 as a specialized cable tray manufacturer, and has been a leader in the domestic tray industry,

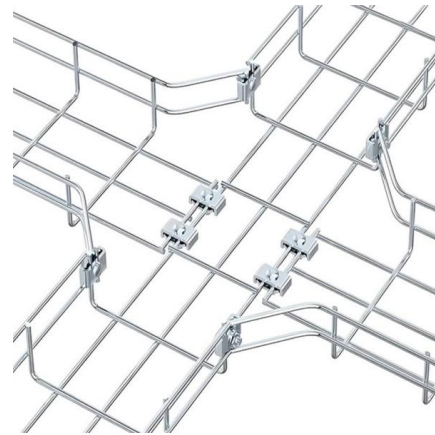

Wholesale Cable Trays Korea Products at Factory Prices from

Global Sources has a full-scale list of wholesale cable trays korea products at factory prices featured by verified wholesalers & manufacturers from China, India, Korea, and other countries to satisfy all the

Top Cable Tray Manufacturers Worldwide: A

Discover leading cable tray manufacturers worldwide, including top companies in Europe, South America, North America, Africa, and Asia. Learn

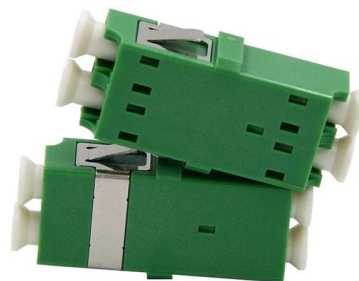

Cable Trays

At Altawakol NTT, we specialize in providing high-quality cable tray solutions tailored to the specific needs of our clients in Egypt. Our products are designed to meet



Cable Trays Market , Industry Report, 2031

The different types of cable trays used in various industries are cable ladder, solid bottom, and trough cable tray. According to the cable trays market sales analysis,



Cable Tray In North Korea

We offer Cable Tray in North Korea in different specifications at competitive market prices. Our range is customized and passes stringent quality tests, before reaching the market.

Perforated Cable Tray In South Korea

Cost-Effective: The lighter weight of perforated trays translates to lower material and transportation costs. Top Perforated Cable Trays Suppliers in South Korea Our perforated cable trays are



Wholesale Cable Trays Korea Products at Factory Prices from

Find wholesale cable trays korea manufacturers from China, India, Korea, and so on. Source good quality cable trays korea products for sale at factory prices from online Chinese, Indian, Korean, and

List of Cable Tray Companies in Korea



Wonchang Corporation. Wonchang Corporation is a specialized organization for manufacturing composite Cable Tray, Grating and Pipe. We have been successfully supplying the products to

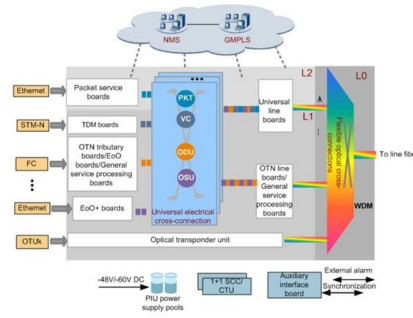

Cable Tray Market Size, Share , Growth Analysis

The global cable tray market size was valued at \$6.41 billion in 2025 & is projected to grow from \$7.34 billion in 2026 to \$16.14 billion by 2034.

Cable Tray Manufacturers & Suppliers in South Korea , Trademo

Find and discover Cable Tray manufacturers and suppliers for all products in South Korea, featuring details on their shipment activities, trade volumes, trading partners, and more. View all cable tray

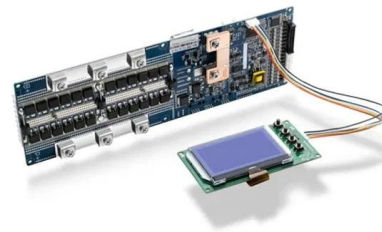

Cable Tray In South Korea

Galvanized Cable Tray As part of our excellent Cable Tray Range, we are proud to offer super strong Galvanized Cable Trays. These specially tailored Galvanized Cable Trays are manufactured using



South Korea Metal Cable Trays and Ladders Market Size



The South Korean market for metal cable trays and ladders has demonstrated consistent growth driven by expanding infrastructure, industrial automation, and digital transformation initiatives.



Contact Us

For datasheets, pricing, or custom high-speed optical interconnect solutions, please visit:
<https://syropy.com.pl>