

How to adjust an RJ45 optical power meter

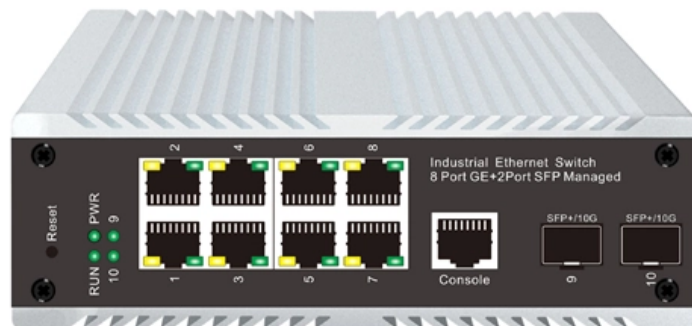



Overview

Once connected, turn on the optical power meter and let it warm up for a couple of minutes. How to Use Optical Power Meter TR-504 | Optical Power Meter Working| Testing OPM, VFL, RJ45 | TRICOM In this video, we walk you through how to use the TRICOM TR-504 Optical Power Meter and explain how it works. These measurements are accomplished using either collimated-beam or connectorized-fiber. Below are general answers on how to operate, maintain, and calibrate an optical fiber ranger from the list of GAO Tek's optical power meters. Next press and hold the Mode Button until you hear a short beep then a long beep. REF/dB key: Short press the dB to switch unit, click once nW/dBm/dB to enter the upper clear data, press and hold until REF is displayed on the screen, and set the current optical power as reference value, enter the relative optical power test mode, the screen will display the setted reference.



How to adjust an RJ45 optical power meter



User's AQ2180 Manual Optical Power Meter User's Ma

Introduction The AQ2180 series are full featured palm sized and lightweight optical power meters designed for use with an optical Light source to perform optical loss measurements on optical fiber

Optical Power Meter User Guide

OR The RP560 is an optical power meter used for verifying the proper function of fiber optic networks. This document will serve as an overview of the major functions and features of the device.



application note 015 Calibration of optical power meters

This application note demystifies how EXFO's IQS-12002 Optical Calibration System can guide you through the calibration of power meters, covering issues such as traceability and technical

OPM200_Kurzanleitung_en_web

NetPeppers OPM200 OPM Measuring Range
Resolution Accuracy VFL Wavelength VFL Output
power Max Supported Length RJ45 Test -70 to +6
dBm 0.01 dB \pm 5% 650 nm \pm 20 nm < 1 mW
(laser class

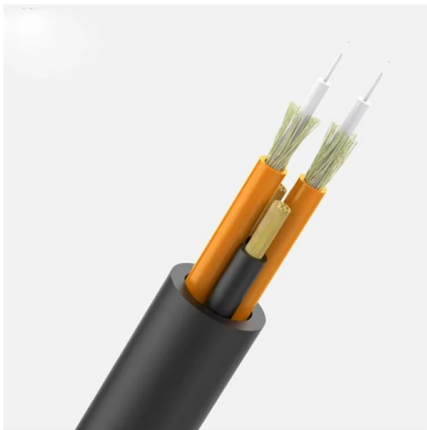
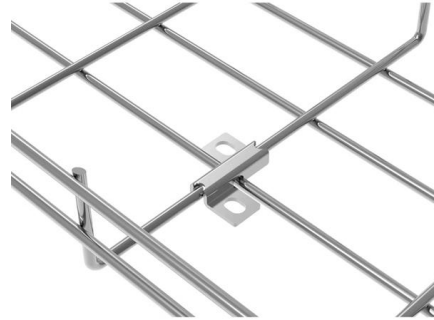

How to use optical fiber power meter?

How To Calibrate Your Power Meter Regular calibration, or fine adjustment, of your optical fibre power meter is essential to ensure it provides you with accurate measurements. This is

How to Use Optical Power Meter TR-504

Learn how to test fiber optic cables, OPM, VFL, and RJ45 cables with this powerful tool.



How to: PM-200B Power Meter Basic Operation and Functions

The Precision Rated Optics PM-200B Power Meter comes in the RCT Option 2 Kit. In this video, senior instructor Joe Cairone reviews the basic operation and functions of the PM-200B Power Meter.



How to measure with the optical pon power meter?

Optical Power Measurement Used when you need to see how much light is passing through a fiber optic cable. It matters 'cause it allows us to verify our communication methods are



How to calibrate your optical fiber power meter?

The Working Principle of Calibrating An Optical Power Meter
Primary Reference Standard
Transfer Standard
Tunable Laser Diode
Optical Power Measurement System
Conclusion
An optical power meter is the most common type of test equipment used to support fiber optic system. NIST developed a testing system to provide absolute power calibrations for optical power meters. These measurements are accomplished using either collimated-beam or connectorized-fiber configurations at the three principle wavelength regions us
See more on fiberoptics4sale GAO Tek

Operation, Maintenance & Calibration of Optical Power Meters

Learn how to operate, maintain, and calibrate GAO Tek's Optical Power Meters with detailed guidelines for accurate fiber optic measurements.

MAY14 Series Optical Power Meter with VFL and RJ45 Cable Tester

How to measure power in optical fiber with OPTICAL POWER METER and other elements (dBm) [mini lab] The Iran War Expert: I Simulated The Iran War for 20 Years. Here's What Happens Next



5 Tips for Accurate Optical Power Meter Readings

Make sure that your power meter is compatible with the wavelength of the signal you are measuring. By following these tips, you can ensure that your optical power meter readings are as

What Is the Ideal Wavelength Range for an Optical Power Meter?

Explore the importance of understanding wavelength range in optical power meters for accurate measurements in optical applications. Learn about the impact on measurement accuracy, factors



How to calibrate optical power meter?

Using the common methods and tools mentioned in the step-by-step guide, you can keep your optical power meter accurate and reliable. Calibrating your equipment regularly is key

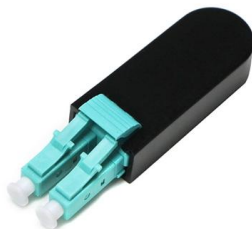



How to Calibrate an Optical Power Meter

Learn what is the best way to calibrate an optical power meter for accurate and reliable measurements of optical signals in optical engineering applications.

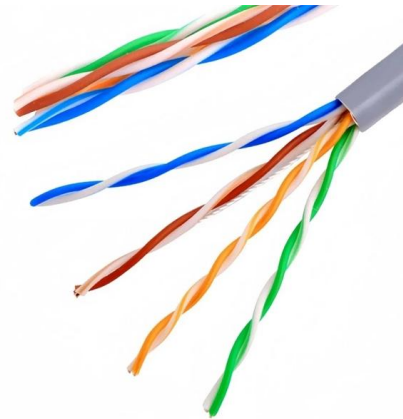

How to Calibrate Fiber Optic Testing and Measurement Equipment

Learn the steps to calibrate four common fiber optic devices: power meters, light sources, OTDRs, and OSAs. Find out what reference equipment you need and how to adjust your settings.

Optical Power Meter Usage and Selection Guide

Optical power meter is one of these fiber optic testing tools designed for fast and easy optical power testing and measurement. There is a wide

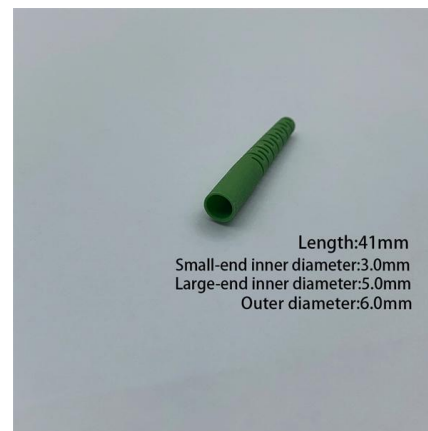

VISUAL FAULT LOCATOR, OPTICAL POWER METER, AND RJ45

Basic Tester Instructions 1: Press the on button to start the tester default (10 minutes). Auto-shutdown function can be turned on or off by pressing this button. The power icon on the upper left of the screen



How to Calibrate Optical Power Meter and Optical light Source Sets

You affiliate link goes here : / @thefocom
Calibration of T25m optical power meter & T15M Optical Light Source T25M Optical Power Meter Connector: FC + SC+ 2.5mm universal (1.25mm for LC is



How to use optical power meter?

Optical power meters are specific instruments used to measure the strength of light signals in fiber optic networks. Signaling devices are essential since they give us an indication of the

Noyes OPM 5 Optical Power Meter Guide

OPM 5 Series Optical Power Meters - Free download as PDF File (.pdf), Text File (.txt) or read online for free. This document is a user's guide for the OPM 5 Series

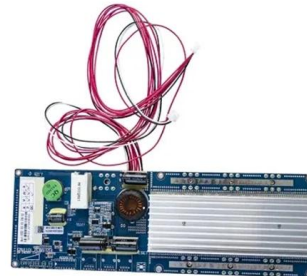

How to Calibrate an Optical Power Meter

In this article, you will learn what is the best way to calibrate an optical power meter, and why it is important to do so regularly.



Beginner's Guide to Power Meter Usage for Optical

Use a power meter for fiber optic testing by cleaning connectors, setting wavelength, calibrating, and following step-by-step procedures for



Optical fiber power meter calibrations at NIST

In this section we will assess the uncertainty for the optical fiber power measurement system. The uncertainty estimates for the NIST optical fiber power measurements are described and combined

Optical Power Meter User Guide

Introduction The RP460 Optical Power Meter is an ultra low cost, and compact power meter used for verifying both absolute and relative power across any given fiber. This document will serve as an



Optical Power Meter User Manual

On the optical power meter interface, short press the "?" key to switch the measurement wavelength. You can choose 7 different test wavelengths, 850nm/980nm/1300nm/1310nm/1490nm/1550nm,



Optical Power Meters: Understand Their Uses and Internals

Optical power meters are indispensable instruments for testing and maintaining modern fiber optic communication and other



OPM (Optical Power Meter)

The Optical Power Meter is small, light and easy to carry large LCD screen. It can be widely used in the test of LAN, WAN metropolitan network. It can be used to test Fiber loss accurately, to

Optical Power Meter User Guide

Reorient or relocate the receiving antenna. Increase the separation between the equipment and receiver. Connect the equipment into an outlet on a circuit different from that to which the receiver is



Optical Power Meters: Understand Their Uses

Optical power meters are indispensable instruments for testing and maintaining modern fiber optic communication and other



Contact Us

For datasheets, pricing, or custom high-speed optical interconnect solutions,
please visit:

<https://syropy.com.pl>