

How to weld cable trays with a welding torch

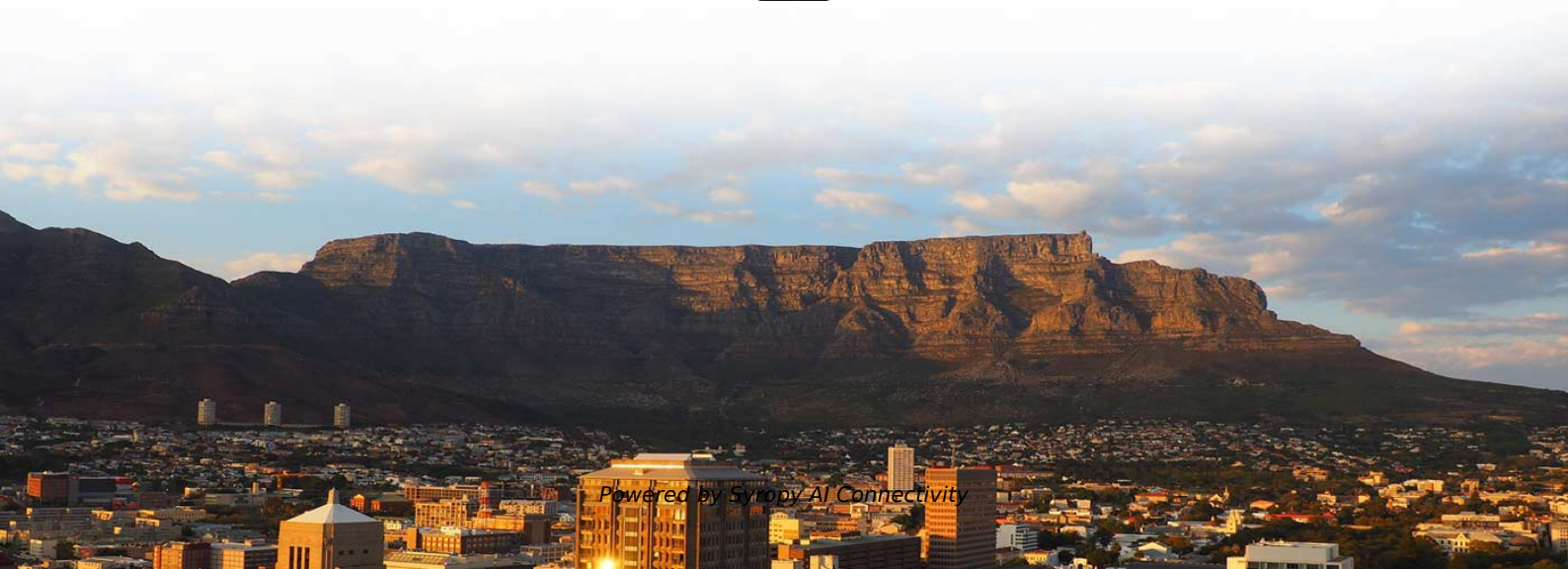



How to weld cable trays with a welding torch



Mastering Cable Tray Welding: Tips for Seamless Installations

Cable tray welding is a critical process for assembling secure and durable cable tray systems. Whether for industrial or commercial applications, the steps and techniques involved ensure safety, stability,



What is Torch Welding and How to Use It: A Comprehensive Guide

Whether you are a seasoned welder or a beginner exploring the world of welding, this comprehensive guide will shed light on the intricacies of torch welding, its application areas, and how you can master

How to Use a Welding Torch: A Beginner's Guide

How to Use a Welding Torch: A Beginner's Guide
In a variety of fields, including construction and vehicle repair, welding is a crucial ability. At the heart of the welding process is the welding torch, a powerful



How to Torch Weld: 7 Steps

Torch welding is a powerful technique that can be used across various applications when done right. By following these seven steps, you can ensure that you are well on your way to mastering this essential



Torch Cutting Basics Everyone Should Know , Oxygen & Acetylene Fuel

Testing Day at the Welding Lab , How do I Pass my Pre-Employment Weld Test? CUTTING TORCH BASICS (SECRET TO A CLEAN CUT EVERY SINGLE TIME) How To Chainsaw Like a Boss. This Could Save

How To Torch Weld Aluminum - Achieve Strong, Clean Joints

Torch welding aluminum involves using a focused flame to melt both the base metal and a filler rod, creating a strong bond. It requires meticulous cleaning,

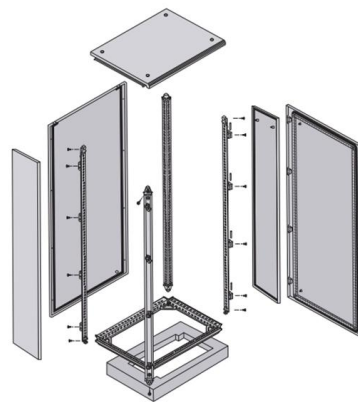

Cable tray support and its welding method

As described above, the cable tray support and the welding method according to an embodiment of the present invention can weld the welding area by the operator alone while the joint

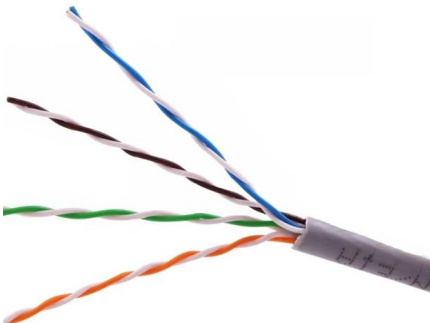

How to Weld Aluminum with a Torch Like a



Learn how to weld aluminum with a torch using flux, filler rods, and key tips for clean, strong joints in your workshop or garage.



How Can You Weld with a Torch: A Complete Guide to Torch Welding

A good weld should have a smooth, shiny appearance, free of excess spatter or gaps. Practical Applications for Torch Welding The flexibility of torch welding allows for many practical applications.

How to Torch Weld: A Comprehensive Guide for Beginners

Title: How to Torch Weld: A Comprehensive Guide for Beginners Introduction: Torch welding, also known as oxy-fuel welding, is a versatile and effective method for joining metals. In this

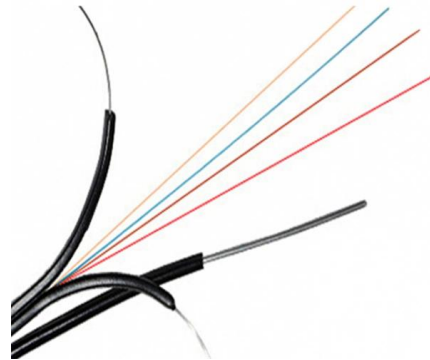

How to Weld with a Torch , A Detailed Guide 2023

Welding with a torch, also known as oxy-fuel welding or gas welding, is a versatile and commonly used method for joining various metals. Whether you need to weld



What is Torch Welding and How to Use It: A Comprehensive Guide

Title: Torch Welding Demystified: A Comprehensive Guide to Mastering this Essential Technique Introduction: Torch welding, also known as gas welding or oxy-fuel welding, is a versatile and widely



Hilti solutions for fastening on steel

The fixing technology is called blunt tip self-welding, where a pilot hole is done and then a threaded stud is screwed into the hole. The threaded stud has a diameter



How to build Cable Tray , Wire Mesh Cable Tray

In this video, I will show how to build cable tray wire mesh with a wire mesh welding machine. ---RKM Machinery more



Welding expertise with battery trays

Battery trays, which are often installed in the vehicle underbody, must meet high quality standards in terms of crash behavior and tightness. The industry is,



How to Torch Weld: 7 Steps (with Pictures)

Learning the basics of torch welding is the first step in becoming proficient with many types of welding. However, mastering welding is something

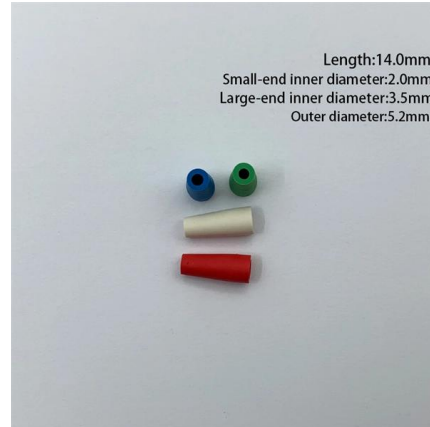

How to Connect Welding Cables Safely and Efficiently

How to Connect Welding Cables To connect welding cables, it is important to consider the polarity requirements of the welding process. Polarity, whether positive or negative, determines the

How to make Cable Tray Mesh? Cable Tray Wire Mesh Welding

This video will show the complete process of manufacturing cable tray mesh using advanced welding machines. Watch how precision welding and automation technology transform raw materials into high

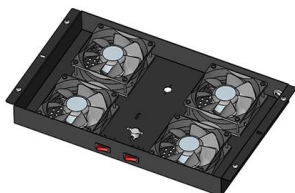

How to Weld with a Torch

There are many ways to weld without a welder, including with a torch. Torch welding uses a combination of gas and oxygen to create a combustible



Industrial Welding Work for Electrical Cable Tray

SEWP SERVICES Pvt. Ltd. showcases precision welding work during the installation of industrial cable trays for heavy electrical wiring connected to generators and fire pumps.

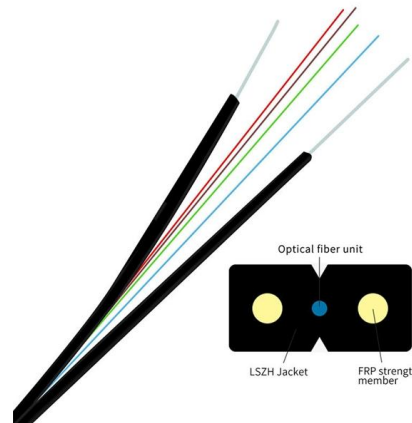

Cable tray support and its welding method

As described above, the cable tray support and the welding method according to an embodiment of the present invention can weld the welding area by the operator alone while the joint surface formed at

How to Weld Stainless Steel Cable Tray Mesh Efficiently?

Learn how to weld stainless steel cable tray mesh efficiently using an automatic mesh welding machine. Discover key technologies such as servo mesh pulling, hook systems, and high-precision welding for



cs-178-project/imdb.vocab at main · apmalani/cs-178-project

Contribute to apmalani/cs-178-project development by creating an account on GitHub.



Utility Cable Support Welding Guide

Welding Metal Supports for Utility Cables: A Comprehensive Guide In the ever-evolving world of utilities system construction, welding plays a crucial and multifaceted role. From ensuring structural integrity



How to Weld Aluminum With a Torch? Quick Tips

In this guide, you'll learn about types of welding torches, things you'll need, steps to weld aluminum with a torch, safety tips, and common issues you

How to Torch Weld: 7 Steps (with Pictures)

Does anyone have a weld procedure for welding of galvanised carbon steel electrical cable tray?



How to Weld with a Torch

Most people think that you can only weld with a welding machine. The second you start learning more about welding, you realize that isn't true. There



How to build Cable Tray , Wire Mesh Cable Tray Welding Machine

In this video, I will show how to build cable tray wire mesh with a wire mesh welding machine. ---RKM Machinery Do you know how many steps are needed to make

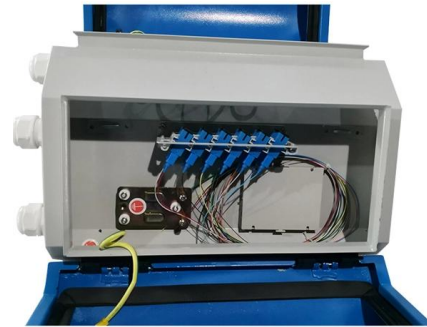

Contact Us

For datasheets, pricing, or custom high-speed optical interconnect solutions, please visit:
<https://syropy.com.pl>