

How to wire the optical sensor module in series

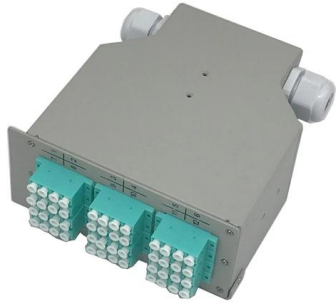



How to wire the optical sensor module in series



Complete Guide to Photoelectric Sensor Wiring and

This comprehensive guide will walk you through everything you need to know about wiring, setting up, and troubleshooting photoelectric sensors in

[unsupervised_topic_modeling/topics/en/17/100/100/topics](#) at

Contribute to [annontopicmodel/unsupervised_topic_modeling](#) development by creating an account on GitHub.



Using an Optical (IR) sensor with Arduino

This short tutorial introduces the Optical (infrared) distance sensor (Sharp GP2Y0A21YK0F). It is assumed you have installed the Arduino IDE and

Wiring 2 Proximity Sensors in Series #howto #sensor

And series wiring with sensors is commonly used in automation to expand the detection range and enhance sensing capabilities.



An easy way to remember PNP and NPN sensor wiring

There are 2 different types of inductive proximity switches, optical sensors and capacitive switching sensors: PNP sensors and NPN sensors. Here

Document:

The I/O modules in each section are grouped for AC, DC Sourcing (PNP) and DC Sinking (NPN) sensor operation. The swing arm and wiring diagrams are grouped in AC, PNP and NPN sections.



Your Practical Proximity Sensor Wiring Diagram Guide

A proximity sensor wiring diagram is just that--a simple illustration showing you exactly how to hook up the sensor to a power source and a control device like a PLC.





Series & Parallel Connection for NPN & PNP sensors

Series & Parallel Connection for NPN & PNP sensors. POB 1778 Greer, SC 29652 414 West Poinsett Street Greer, SC 29650 mike@traskinst Ph: 864-848-3993 :

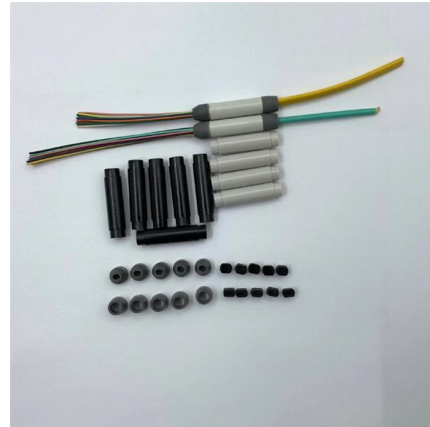

How to Use Optical Sensor: Examples, Pinouts, and Specs

Learn how to use the Optical Sensor with detailed documentation, including pinouts, usage guides, and example projects. Perfect for students, hobbyists, and developers integrating the Optical Sensor into

Optical Sensor : Circuit, Working, Interfacing & Its

An optical sensor definition is; a sensor that is used to convert the light rays into electronic signals. These sensors help in measuring the incident



Series Photoelectric Smoke Detector

Models 2W-B and 2WT-B are 2-wire photoelectric smoke detectors; models 4W-B and 4WT-B are 4-wire photoelectric smoke detectors. All models in-clude a state-of-the-art optical sensing chamber



Photoelectric Sensor Wiring, Setup, and Troubleshooting

Photoelectric sensor wiring First, we will show you how to wire the Through-Beam photoelectric sensor emitter. Through-Beam sensors have two separate devices,

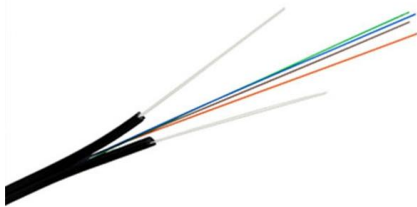
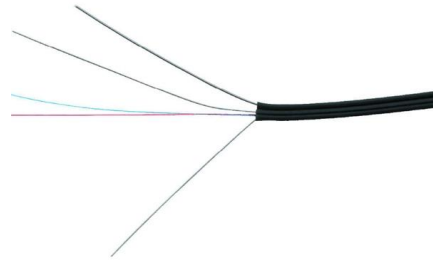

SHIMADZU CORPORATION

Since 1875, Shimadzu is pursuing leading-edge science and technologies in analytical and measuring instruments including chromatographs and mass

How to Use Optical Sensor: Examples, Pinouts, and Specs

Learn how to use the Optical Sensor with detailed documentation, including pinouts, usage guides, and example projects. Perfect for students, hobbyists, and



Connection of sensors in series and parallel

Sensors can be connected in series with a load. For proper operation, the load voltage must be less than or equal to the minimum supply voltage minus the voltage drops across the series connected



How to Wire Proximity Sensors in Series for Improved

Learn how to wire proximity sensors in series for efficient and accurate detection. Find step-by-step instructions and tips for optimal sensor placement and wiring



Complete Guide to Photoelectric Sensor Wiring and

Learn how to properly wire, set up, and troubleshoot photoelectric sensors. Includes step-by-step instructions, wiring diagrams, and solutions to

Optical Sensor : Circuit, Working, Interfacing & Its

Generally, optical sensors comprise encoders, optical measuring instruments, gratings, optical fibers & other devices. So all these devices help



OpticalSensor Learning Wiring

Transmissive optical sensor without aperture Vishay TCST1000/TCST2000 by Diana Fernandez Demonstrates how to use a transmissive optical sensor. This sensor is used in mechanisms to detect



Microsoft - AI, Cloud, Productivity, Computing, Gaming

Explore Microsoft products and services and support for your home or business. Shop Microsoft 365, Copilot, Teams, Xbox, Windows, Azure, Surface and more.



Photoelectric Sensor Wiring, Setup, and Troubleshooting

First, we will show you how to wire the Through-Beam photoelectric sensor emitter. Through-Beam sensors have two separate devices, one is called the emitter and



Proximity Sensor Series Connection Diagram

Hi, in this article, we are going to see the connection diagram and wiring procedure for connecting multiple proximity sensors in series. A proximity



IR Sensor Module

What is an IR module? How does it work ? And most importantly, how can you use it? Also included, embedded C programs for simple line follower.



Interfacing R307 Optical Fingerprint Scanner with

In this tutorial, we will learn how an Optical Fingerprint Scanner works and how we can interface the R307 fingerprint scanner module to an Arduino

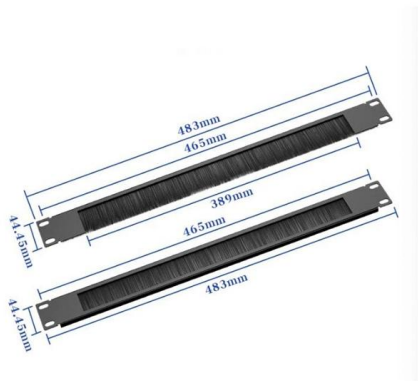
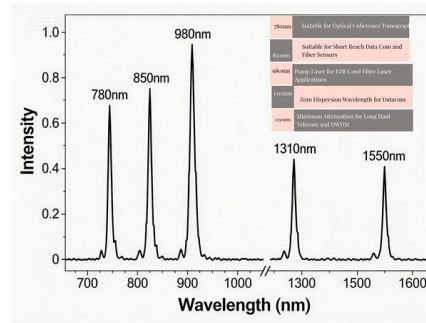

How to Use TCRT5000 IR Sensor Module With Arduino

How to Use TCRT5000 IR Sensor Module With Arduino UNO: In this tutorial, we are going to teach you some basics on using TCRT5000 IR Sensor Module. These

How to Interface IR Sensor with Raspberry Pi , IR

Raspberry Pi IR Sensor Interface Now that we have seen a little bit about the IR Sensor Module and its connections, we will proceed with interfacing



QRD1114 Optical Detector Hookup Guide

Introduction The QRD1114 is a half-LED, half-phototransistor, all infrared reflective optical detector. It can be used to sense objects in close proximity or even detect



PLC Sensor Integration Guide: Wiring, Types & Best

Master PLC sensor integration. Learn to match analog/digital signals to I/O modules, properly wire industrial sensors, and avoid common installation

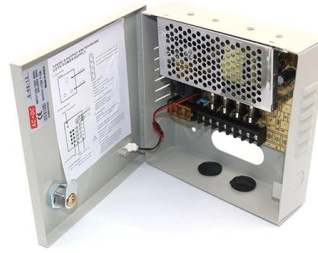

WS2812B and optical sensor devices in series

Each of this "devices" should be series connected through a 3 or 4 pin cable (VDD 5V, VSS GND, 1 or 2 DATA), while the first one will be attached

Contact Us

For datasheets, pricing, or custom high-speed optical interconnect solutions, please visit:
<https://syropy.com.pl>