

# **Odfdc interface**





## Odffc interface

---

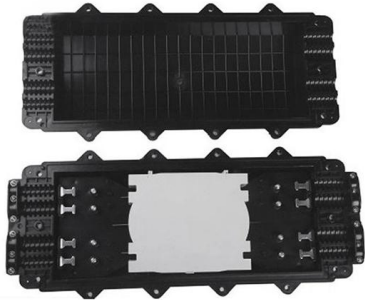

### **FSlogix ODFC container and Outlook OST file , Microsoft Community**

There is a host pool with a couple of session hosts. Users' profiles are stored in file share by means of FSLogix with Microsoft apps separated with ODFC container. Having all that set up the way I

### **Interface Status**

The Interface Status screen allows you to manage OPERA IFC8 by monitoring a variety of interfaces and configuring how these interfaces interact with OPERA.



### **Off Line**

On its own Off Line can present a staccato, banded effect with interesting variations. Playing with the bold solids from On Line™, Off Line veers in a new direction by creating transitions between

### **Setup · Ultrawipf/OpenFFBoard Wiki · GitHub**

OpenFFBoard is a universal force feedback interface for DIY simulation devices - Setup · Ultrawipf/OpenFFBoard Wiki



### Open NAND Flash Interface Specification

This specification defines a standardized NAND Flash device interface that provides the means for a system to be designed that supports a range of NAND Flash devices without direct design pre

### Devices -- OPNsense documentation

Devices Besides wired, wireless and VPN interfaces, there are also some other, virtual interfaces, as well as some miscellaneous interface-related. These options can be found under Interfaces ?



### Configure object specific container settings

Configuration settings for profile containers and ODFC containers are applied at the computer or virtual machine level. These system-wide settings can

hendrikheinz/INTERFACE-force-field-and-



## surface-models

A force field for the simulation of inorganic-organic interfaces (INTERFACE-CHARMM, INTERFACE-PCFF) Download a .zip file containing all parameters



## Out-of-band management

An older version of out-of-band management is a layout involving the availability of a separate network that allows network administrators to get command-line

## ODV: ODV

ODV development has received funding from various European Union programmes under grant agreement numbers 101058785 FAIR-EASE, 730960 SeaDataCloud,

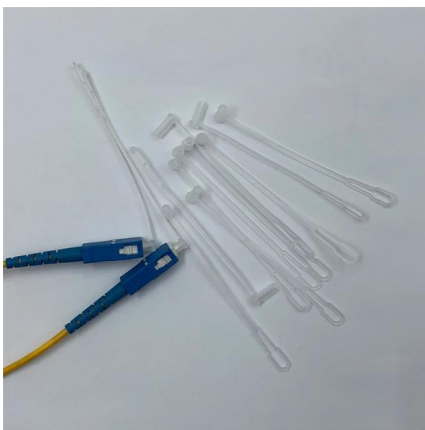

## hendrikheinz/INTERFACE-force-field-and-surface-models

Currently, the PCFF-INTERFACE, CHARMM-INTERFACE, and CVFF-INTERFACE force fields are included. They contain accurate parameters for the following



## 15 Useful ifconfig Commands to Configure Network in Linux

In this article, you will learn how to list, configure, enable, disable, and troubleshoot network interfaces in Linux using ifconfig commands with examples.



## MS FSlogix Part 2: How to Configure ODFC Container for

How to Configure ODFC Container for roaming profile solution in OS 2025 In this part of video we will execute following activities1. Network Share for roamin

## Solved: Clear the config off an interface

Is there a way to clear the configuration off a single interface in one shot, and set it back to defaults? I have a 6509 running an IOS. Thanks, Mike

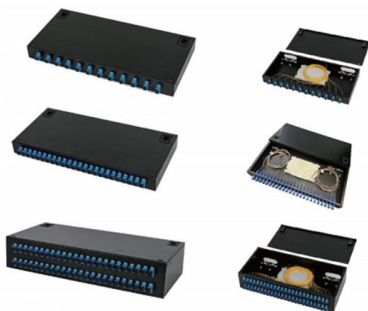

## ODrive guide · Ultrawipf/OpenFFBoard Wiki · GitHub

You should configure your ODrive to be able to control your motor before connecting to the OpenFFBoard USB interface. The Getting Started guide

## Configure ODFC containers



FSLogix ODFC containers are a subset to the profile container and are used to redirect specific Microsoft 365 app data into a VHD stored on a storage provider. The most common storage



### Importing and exporting files

4. From this interface, you can import files by dragging and dropping them, or export them by clicking Download to save them to your computer. You can also select a

### Merging Profile and ODFC containers? : r/fslogix

Under most circumstances the data in the ODFC container is not user data that must be saved because it is most commonly sourced from a cloud resource (Exchange

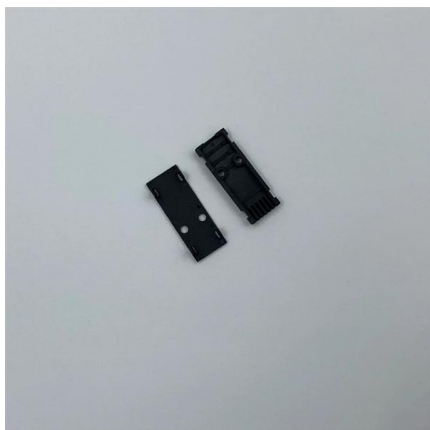

### Grok

Grok is an AI assistant built by xAI. Chat, create images, write code, and get real-time answers from the web and X.



## On Line & Off Line: Commercial Carpet Tile Collection

Off Line from Interface Off Line Skinny Planks are transitional companions to our popular On Line carpet tiles. This style creates transitions between neutrals and



Component Diagram

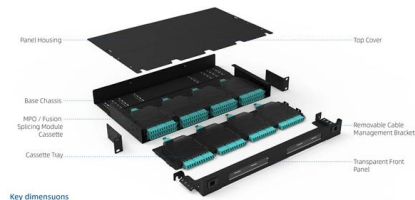

Key dimensions

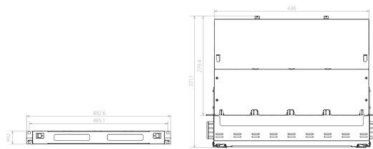

## Enabling and disabling network card through commandline

Can anybody help me to how can I enable and disable network card through terminal?

## Implementing Basic OSPF Features > "Do I Know This Already?" Quiz

The ip ospf command in interface configuration mode  
The router ospf command in interface configuration mode  
The network command in interface configuration mode  
6. An enterprise avoids

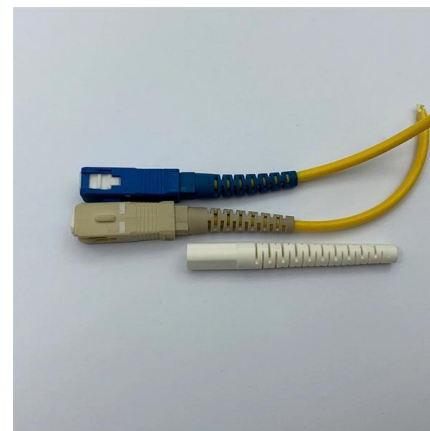

## OPPCharge Common Interface for Automated Charging of Hybrid

stry standards, with the intention of supporting a common charging interface for commercial vehicles. Supplier-independent interface can lead to cost reduction, benefiting the cit



### Off Line: On Line & Off Line Collection Carpet Tile by

On its own, Off Line carpet tile can present a staccato, banded effect with interesting variations. When paired with the bold solids from On Line, Off Line veers in a new



### All discretés are not created equal

In modern military, aerospace, and industrial control systems, the Discrete I/O interface is so common that it is often overlooked in the early design

### HP Tuners - Home

MULTI-PROTOCOL VEHICLE INTERFACE  
Automotive Calibration & Diagnostic Tool Say hello to the latest generation OBDII interface by HP Tuners. Use MPVI4

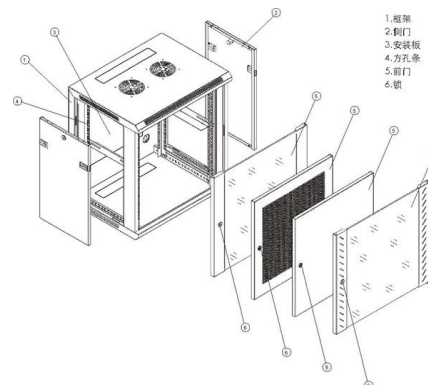

### MIPI Alliance Specification for RF Front-End Control Interface

The RFFE interface is based on MIPI Alliance Specification for System Power Management Interface (SPMI) . The RFFE interface is intended to be efficient, flexible, and extensible,

Configurator guide ·  
Ultrawipf/OpenFFBoard Wiki · GitHub



Optionally the GUI (main.py) can be executed directly from the repo if python and its requirements are installed. Default language is English, and all

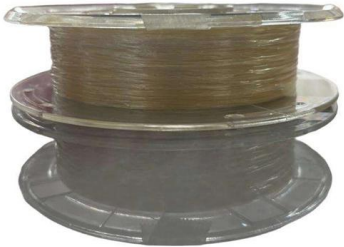

### **Tella -- the all-in-one screen recorder**

Your all-in-one screen recorder, to create incredible product demos, tutorials, courses, for Mac & Windows.

## **Contact Us**

---

For datasheets, pricing, or custom high-speed optical interconnect solutions, please visit:  
<https://syropy.com.pl>