

Price Trends of Plastic Optical Cables for Sale

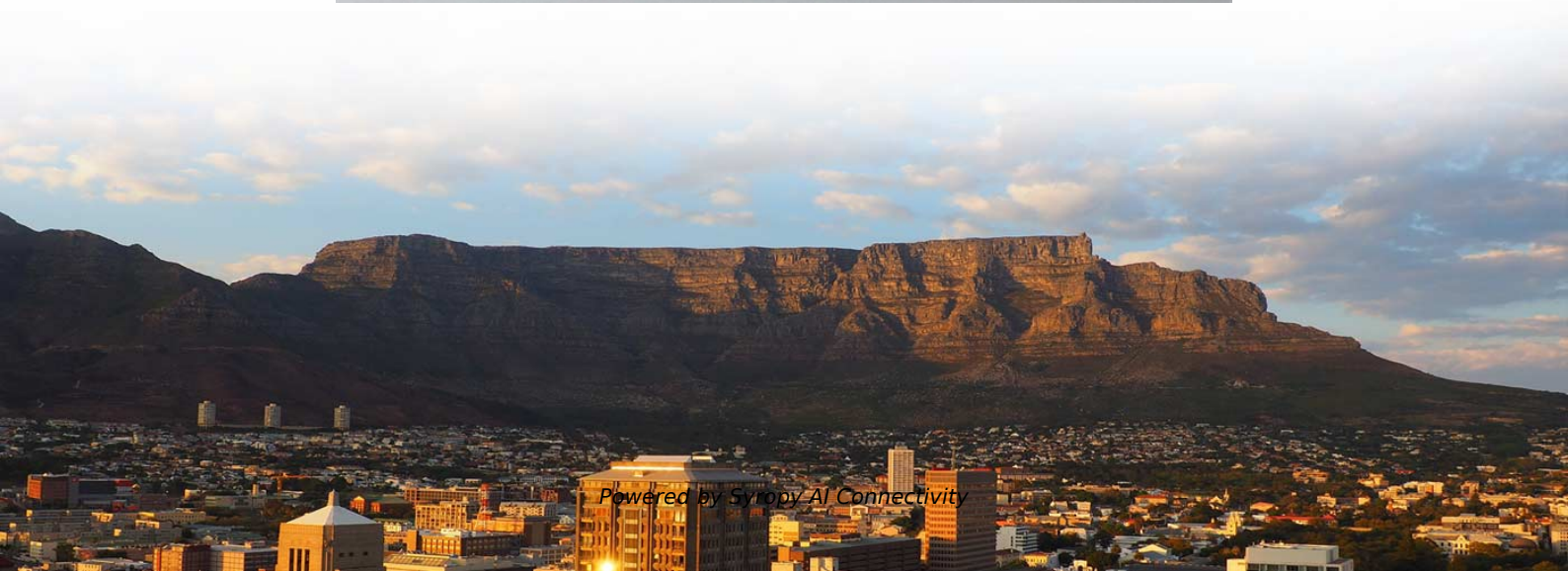

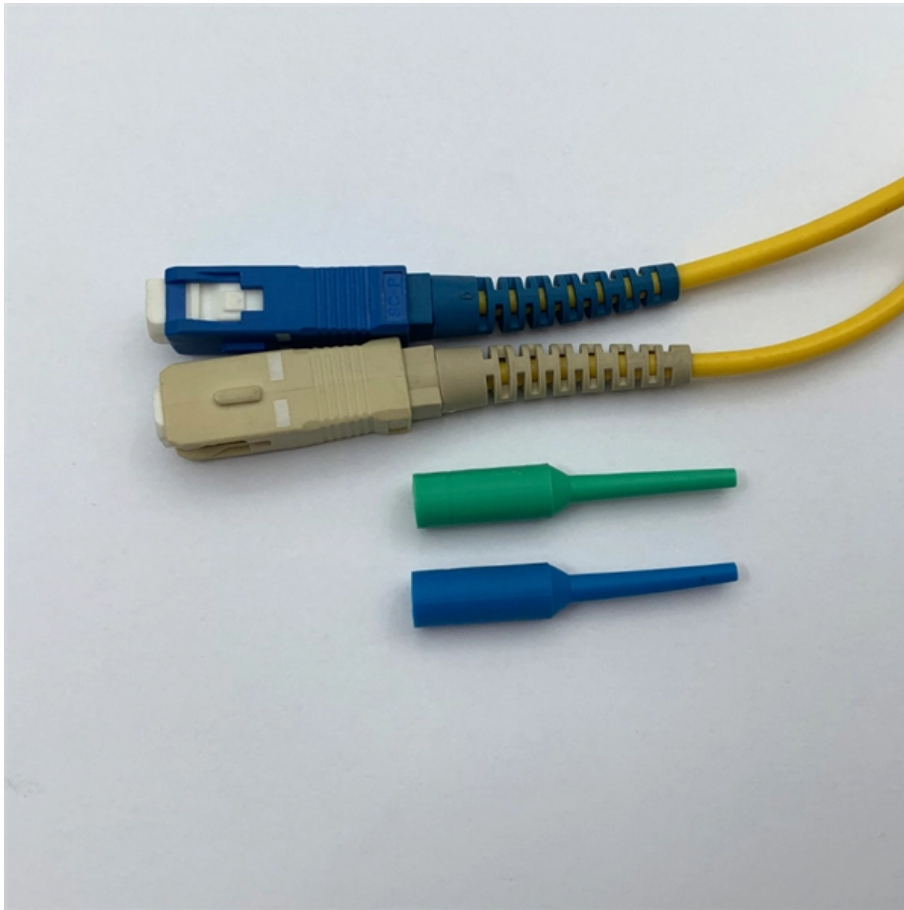

Price Trends of Plastic Optical Cables for Sale



Active Optical Cable Market Size, Share , Report 2035

Key Market Trends & Highlights The Active Optical Cable Market is poised for substantial growth driven by technological advancements and



Fiber Optic Cable Market Size, Demand, Growth By 2035

In 2026, the Fiber Optic Cable Market stood at USD 5.54 billion and is forecasted to hit USD 11.11 billion by 2035, expanding at a CAGR of 7.21%.

Optical Fiber and Plastic Conduit Market Size, Share, and Trends

The global Optical Fiber and Plastic Conduit market size was estimated at USD 12.58 Billion in 2024 and is estimated to grow at a CAGR of 20.85% from 2025 to 2032.



Business Insider

Business Insider tells the global tech, finance, stock market, media, economy, lifestyle, real estate, AI and innovative stories you want to know.



Plastic Optical Fiber (POF) Cables Market Growth Outlook: Global

As the POF Cables Market is expected to grow at a CAGR of 11.5% during the forecasted period, these insights will help enterprises identify lucrative opportunities, optimize supply chains, and



Wire & Cable Prices

CRU provides comprehensive, accurate and up-to-date price assessments and research reports for bare optical fibre across various key regional markets, combined with insights into the



Fiber Optic Cable Market Size, Share , Analysis 2035

The Fiber Optic Cable Market is experiencing heightened demand for high-speed internet services. This trend is largely driven by the proliferation of

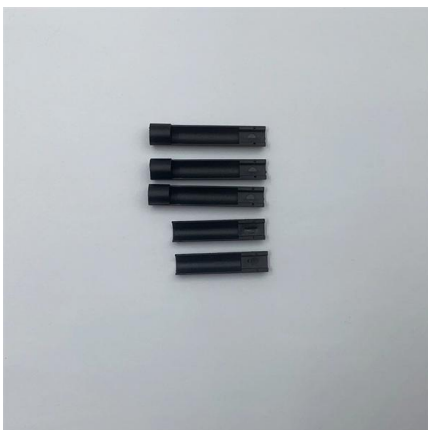



Fiber Optic Cable Price in 2026: Real Market Data for March

The fiber optic cable price has surged dramatically in 2026. Based on real market data as of March 9, this report analyzes fiber price increases of up to 650%, finished cable price changes,

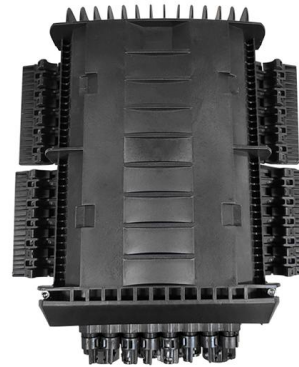

Plastic Optical Fiber Market Size, Share, Trends, Report

Plastic Optical Fiber Market is projected to reach USD 21.83 Billion, at a 8.56% CAGR by driving industry size, share, top company analysis, segments

Global Plastic Optical Fiber (POF) Cables Market 2025 by

Chapter 2, to profile the top manufacturers of Plastic Optical Fiber (POF) Cables, with price, sales quantity, revenue, and global market share of Plastic Optical Fiber (POF) Cables from 2020 to 2025.

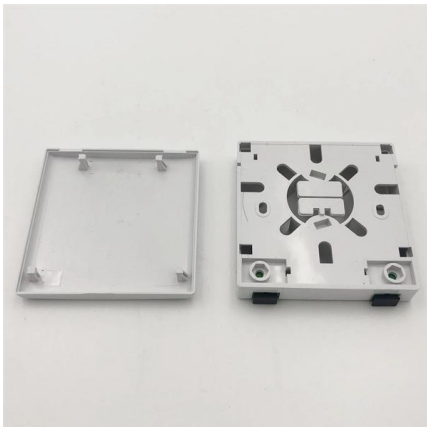

Active Optical Cable Market Size, Share, Trends

The global active optical cable market size was valued at \$1.63 Bn in 2019, is projected to hit \$12.60 Bn by 2028, growing at a CAGR of 27.5% from 2021-2028.



Fiber Optics Market Size, Share & Forecast Report,

Fiber Optics Market Size & Share 2024 - 2032
Market Size by Fiber Type (Glass Fibers, Plastic Optical Fibers), by Cable Type (Single-mode, Multi-Mode), by

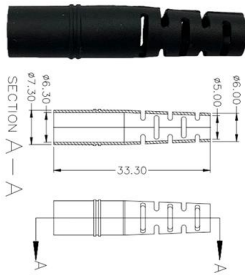
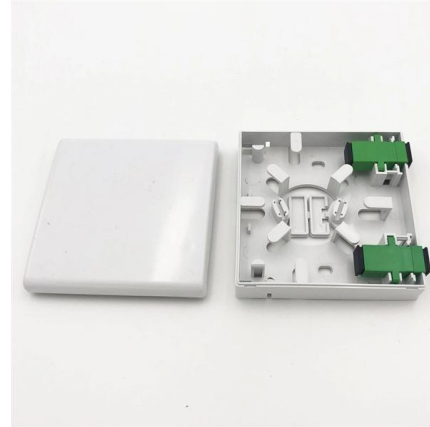

"Plastic Optical Fiber Cable"

Our Plastic Optical Fiber Cable offers exceptional quality and style within the Optical Fiber category. Sourcing optical fiber cable directly through a proven factory OEM distributor offers better

Wire Cable Plastic Market Size, Share & Industry Report

The Wire and Cable Plastic Market will grow from USD 220.18 billion in 2024 to USD 361.55 billion by 2035, at a CAGR of 4.61%.



Plastic Optic Fiber Market Size, Share, Trends, Report

North America remains the largest market for plastic optic fibers, driven by robust demand in telecommunications and data transmission applications.



Plastic Optic Fiber Market Size, Share and Industry

Plastic optic fiber market is projected to reach \$11.4 billion by 2032, growing at a CAGR of 8.6% from 2023 to 2032. The continuous expansion and improvement



Plastic Optical Fiber (POF) Cables 2025-2033 Trends and Competitor

This report provides a comprehensive analysis of the Plastic Optical Fiber (POF) cable market, covering market size, segmentation, leading players, trends, and future growth projections.

Optical Fiber Cable Market 2025

Optical Fiber Cable Market Overview Fiber optic cable is a cable containing one or more optical fibers that are used to carry light. The optical fiber elements are

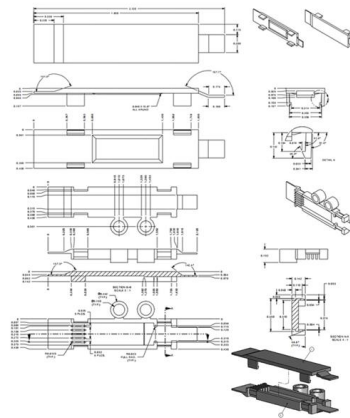

Global Plastic Optical Fiber (POF) Cables Market 2026

The Plastic Optical Fiber (POF) Cables Market was valued at USD 4.24 Billion in 2025 and is forecasted to reach USD 7.47 Billion by 2032, growing at a CAGR of 8.4%.



Fiber Optics Market Size & Share , Industry Report, 2033

Fiber Optics Market Summary The global fiber optics market size was estimated at USD 10.76 billion in 2025 and is projected to reach USD 17.95 billion by 2033,



Plastic Optical Fiber Cables Market Size & Share 2025-2030

Discover the latest trends and growth analysis in the Plastic Optical Fiber Cables Market. Explore insights on market size, innovations, and key industry players.

Wiley Online Library , Scientific research articles, journals, books

Hier sollte eine Beschreibung angezeigt werden, diese Seite lässt dies jedoch nicht zu.



Global Plastic Fiber Optic Cable Market Size, Forecasts 2030

The Global Plastic Fiber optic Cable market accounted for \$XX Billion in 2023 and is anticipated to reach \$XX Billion by 2030, registering a CAGR of XX% from 2024 to 2030. Prysmian



Plastic Optical Fiber Cable Market Size, Share & Trends

The Global Plastic Optical Fiber (POF) Cable Market is projected to grow at a CAGR of 7.1% from 2025 to 2035, driven by increasing demand for high-speed data

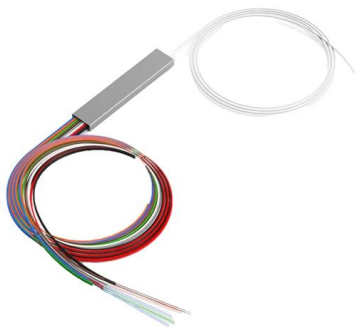

Plastic Optical Fiber(POF) Market Size, Trends, SWOT & Insights

Discover comprehensive analysis on the Plastic Optical Fiber (POF) Market, expected to grow from USD 1.25 billion in 2024 to USD 2.5 billion by 2033 at a CAGR of 8.7%. Uncover critical growth factors,

Fiber Optics Cable Market (2023-2032)

The market for fiber optics cable market is divided into cable types, optical fiber types, application, and geography. By cable type, it is bifurcated into single-mode and multi-mode. By optical fiber material,

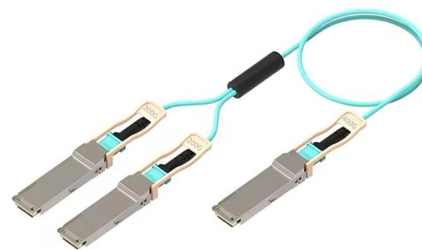

Optical Fiber Cable Market Size, Share, and Trends

The global Optical Fiber Cable market size was estimated at USD 5,896.39 Million in 2022 and is estimated to grow at a CAGR of 12.2% from 2023 to 2030.

Plastic Optical Fiber Market Revenue



Trends and Growth Drivers

The plastic optical fiber market is experiencing substantial growth, driven by the demand for high-speed data transmission and the need for flexible and durable optical fibers. This market overview highlights



Fiber optic cable Market Size, Share & Trends, 2033

Fiber optic cable refers to the network infrastructure solution that transmits data as pulses of light through thin strands of glass or plastic fibers which enables high-speed, long-distance,

Global Plastic Fiber Optic Cable Market Size, Forecasts 2030

In Global Plastic Fiber Optic Cable Market, The ODU Fiber Optic technologies guarantee the highest level of performance and signal stability needed for optical connections.



Contact Us

For datasheets, pricing, or custom high-speed optical interconnect solutions, please visit:
<https://syropy.com.pl>