

Spectrometer and ODF





Spectrometer and ODF

Croatia Spectrometer Market , Size, Trends & Outlook 2032



Croatia Spectrometer Market faces challenges such as high competition, regulatory hurdles, and the need for technological advancements to meet evolving customer demands.

Spectrometry at school: hands-on experiments

Hands-on experiments in spectrometry As part of the project, a range of practical spectrometry activities was developed to raise interest in science, and



ispace and University of Leicester Sign Payload Service Agreement

The payload is a Raman analytical spectroscopy instrument adapted from the original laser-based spectrometer developed for the ExoMars mission, and will be delivered by the University

Wireless Spectrometer (Vis)

The Wireless Spectrometer from PASCO is specifically designed for modern chemistry, biology, and physics labs. With Bluetooth and USB connectivity,

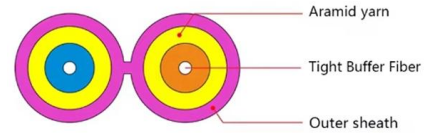

Senegal Spectrometer Market , Size, Share & Forecast 2032

Senegal Spectrometer Market reveals insights into consumer behavior, highlighting preferences in usage patterns and applications across various industries.

Sierra Leone Spectrometer Market (2025-2031) , Revenue & Forecast

6Wresearch actively monitors the Sierra Leone Spectrometer Market and publishes its comprehensive annual report, highlighting emerging trends, growth drivers, revenue analysis, and forecast outlook.

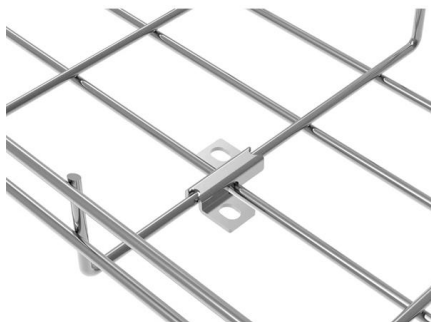
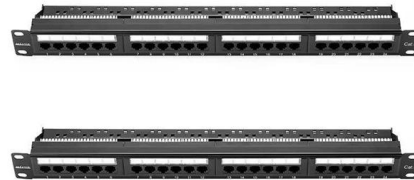

DLP Spectrometer Design Considerations

In order to take advantage of the many benefits of DLP technology in your spectrometer design, several key factors and algorithms must be considered.



Optical Density in Microbiology: Techniques and Applications

Spectrophotometry plays a pivotal role in precise optical density measurement, employing specialized instruments to gauge light absorption by microbial samples. Central to this technique is the



Spectrometer Design Guide

On the following pages are shown two common spectrometer geometries; the transmission grating based and the crossed Czerny-Turner. Also, the figures defines the key design parameters of a

Adafruit AS7341 10-Channel Light / Color Sensor Breakout

Description The Adafruit AS7341 10-Channel Light / Color Sensor Breakout is a multi-channel spectrometer, which is a special type of light sensor that is able to

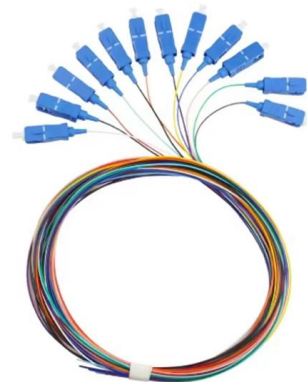

Nicaragua Spectrometer Market , Share, Outlook & Growth 2032

Nicaragua Spectrometer Market analysis highlights the competitive landscape, featuring key players and their strategies to drive innovation and market share.



Characterization of Orodispersible Films: An Overview of Methods and

We provide a relatively novel and inventive disintegration test apparatus, which works using 'Light Dependent Resistor (LDR) and Light Emitting Diode (LED) sensors' for clear and

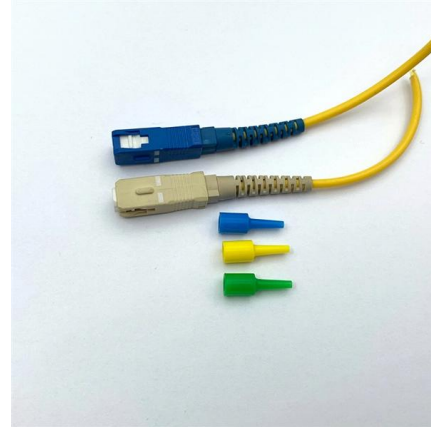

Differences in bacterial optical density measurements between UV

Figure 6 shows the OD of a culture measured on both an Evolution 260 Bio Spectrophotometer and a SPECTRONIC 200 Spectrophotometer. The OD ratio between the two instruments was calculated at

Design and optimization of a spectrometer for Spectral Domain Optical

The spectrometer used in spectral domain optical coherence tomography (SD-OCT) imaging system is a critical component playing an important role in obtaining high quality OCT images.



Key Driving Factors in the North America Near Infrared Band Fiber

The "North America Near Infrared Band Fiber Optical Spectrometer Market" prioritizes cost control and efficiency enhancement. Additionally, the reports cover both the demand and supply



United States Infrared Band Fiber Optical Spectrometer

The United States Infrared Band Fiber Optical Spectrometer market is experiencing significant growth, driven by increasing demand in research, industrial applications, and



Haiti Spectrometer Market (2025-2031) , Revenue & Forecast

6Wresearch actively monitors the Haiti Spectrometer Market and publishes its comprehensive annual report, highlighting emerging trends, growth drivers, revenue analysis, and forecast outlook. Our



Measurement of optical density of microbes by

Spectrophotometers are ideal for measuring microbial concentrations as they provide simple, efficient, and inexpensive OD readings. However, the

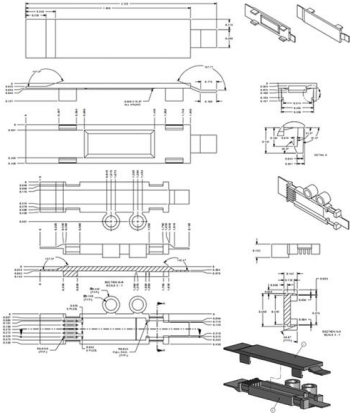

5.1: Vacuum System

5.1: Vacuum System Page ID Table of contents No headers All mass spectrometers operate at very low pressure (high vacuum). This reduces the chance of ions





Estimating microbial population data from optical density

The relationship between OD and cell titer depends on the configuration of the spectrophotometer, the length of the light path through the

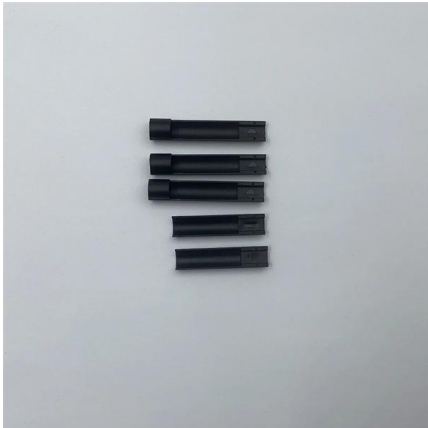

Mali Spectrometer Market (2025-2031) , Forecast & Companies

Mali Spectrometer Market Size Growth Rate The Mali Spectrometer Market is projected to witness mixed growth rate patterns during 2025 to 2029. Growth accelerates to 10.74% in 2028, following an

Spectroscopy: Introduction, Principles, Types and

Introduction Spectroscopy is a scientific technique used to study the interaction between matter and electromagnetic radiation. It helps identify the



Comoros Spectrometer Market (2025-2031) , Outlook Growth

6Wresearch actively monitors the Comoros Spectrometer Market and publishes its comprehensive annual report, highlighting emerging trends, growth drivers, revenue analysis, and forecast outlook.



Analyzing Differences in Bacterial Optical Density Abstract 1730

ound Optical density (OD) measurement of bacterial cultures is a common technique used in microbiology. Researchers have primarily relied on spectrophotometers to make these



Fluorescence measurement using an optical fiber type small

We proposed a small spectrometer that irradiates and receives light with a single optical fiber, and measured the fluorescence of solids and liquids.

(PDF) Atomic Absorption Spectroscopy: Its Principle,

PDF , On May 11, 2024, Vivek Sharma published Atomic Absorption Spectroscopy: Its Principle, Components and Applications , Find, read and cite all the research



Home , Journal of the Iranian Chemical Society

Journal of the Iranian Chemical Society is a peer-reviewed journal publishing in English on experimental, theoretical, and applied research in all branches of chemistry. Covers analytical, inorganic, organic



Spectrometer Tenders , Spectrometer RFP and Bids 2025

Latest global Spectrometer tenders from various sectors and industries. The information on Spectrometer tenders and bids is sourced aggregated from newspapers, e tender portal, etender



Quadrupole mass analyzer

Quadrupole elements In mass spectrometry, the quadrupole mass analyzer (or quadrupole mass filter) is a type of mass analyzer originally conceived by

Raman Spectroscopy and its Application in Nanostructures

Raman Spectroscopy and its Application in Nanostructures is an original and timely contribution to a very active area of physics and materials science research. This book presents the



Contact Us

For datasheets, pricing, or custom high-speed optical interconnect solutions, please visit:
<https://syropy.com.pl>