

Spot Micro-module Suppliers

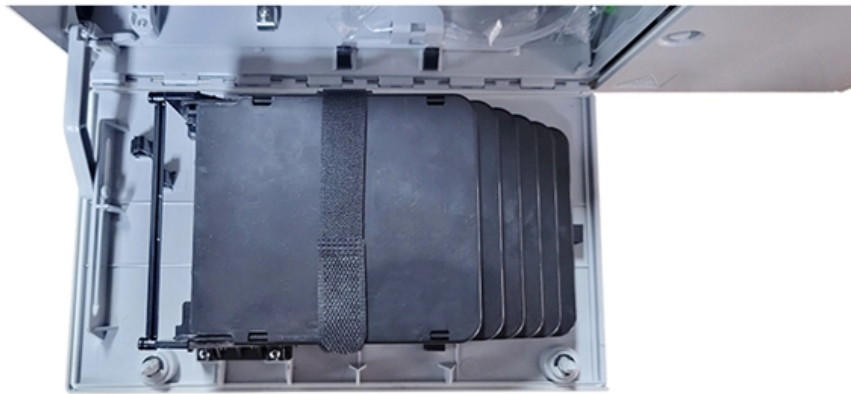



Spot Micro-module Suppliers



SPOT

KAGA FEI Europe offers a wide range of high-quality electronic components. You can either buy directly from the webshop or contact us to get a dedicated

Spot Micro

TPU is basically rubber, you can adjust the legs shoes infill to have more grip. 100% infill will not have a lot of grip since will become a solid piece, but 10% will be soft and will behave

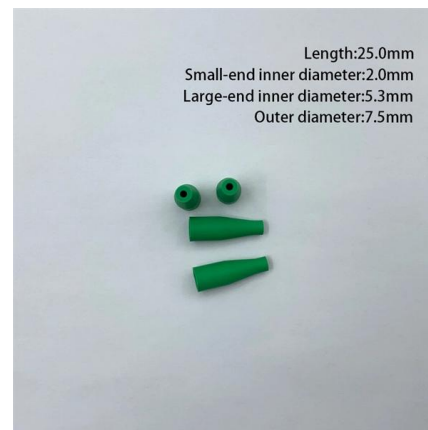

Micro Spike Spot

The LuxR Micro Spot is a miniature low-voltage dimmable outdoor spot light, with a 150mm spike for installing into soil. Ideal for illuminating small trees. Simply plant

GitHub

Overview
General Instructions
Description of ROS Nodes
Additional Project Components
Future Work
External Links and References
The current software supports basic state machine operation of the spot micro robot, orientation contrMy desired future goals for this project, in order of preference, are to:
1 corporate a lidar



(particularly the Slamtec RPLIDAR A1) to achieve simple 2D mapping of a room v2 velop an autonomous motion planning module to guide the robot to execute a simple task around a sensed 2D environment. For example, navigate the perimeter of a room, and dynamically avoid introduced obstacles. See more on github readthedocs.io

Read the Docs

Hier sollte eine Beschreibung angezeigt werden, diese Seite lässt dies jedoch nicht zu.



santiccioli , Flos Spot Module Phosphor LED

Flirting with architecture Structural system integrated into the architecture characterized by direct and indirect lighting gear. Spotlight to be installed on Light

santiccioli , Flos Spot Module Power LED

Flirting with architecture Structural system integrated into the architecture characterized by direct and indirect lighting gear. Spotlight to be installed on Light



Spot Micro ESP32: A Comprehensive Review and Guide for

The Spot Micro ESP32 is a compact, powerful wireless module based on the ESP32-S2 microcontroller, ideal for IoT and embedded projects. It offers Wi-Fi, Bluetooth, 4MB flash memory, and compatibility

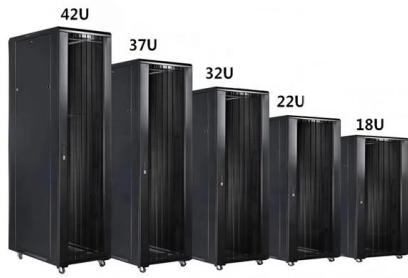

Spot Buy Capability , Tail Spend Management

See how the Spot Buy capability enables effective tail spend management by providing a simple and controlled way to buy from suppliers.



Stellenbosch University , Forward Together

Stellenbosch University is a leading research institution driving knowledge, innovation and transformation through excellence, inclusivity and impact.

display-module

Hier sollte eine Beschreibung angezeigt werden, diese Seite lässt dies jedoch nicht zu.





Top LED Module Spot Light Suppliers: A Comprehensive Guide

Discover the leading suppliers of high-performance LED module spot lights. This in-depth guide explores top brands, product offerings, and key factors to consider when choosing the best LED module spot



Flos Spot Module Power Led 10.5W for Light Cut Mini

Light Cut mini profiles are offered for installation in three different configurations: Perimetral, 70 mm Channel and 140 mm Channel (see diagram in the pictures),

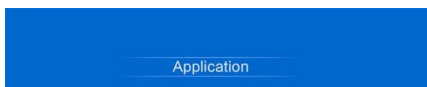

GitHub

Supporting libraries provide additional capabilities, such as mapping through SLAM and a body mounted lidar. The software is implemented on a Banana Pi Zero M2 running Ubuntu 20.04 with ROS Noetic

A New Generation of Laser Spot Tracker

A New Generation of Laser Spot Tracker with wide flexibility for missile, airborne, ground and multi sensor pod tracker applications.





santiccioli , Flos Spot

Ultra-miniaturized luminous objects Innovative program of ultra-miniaturized structures in recessed and surface versions. Accent lighting LED module to

MICRO SPOT

STANDARD - self contained - 220 - 240VAC 50 - 60Hz PREMIUM - self contained - 220 - 240VAC 50 - 60Hz MSU - fixture MICRO SPOT with optic for universal uses



Spot Welding Machine

Find here Spot Welding Machine, Spot Welder manufacturers, suppliers & exporters in India. Get contact details & address of companies manufacturing and supplying

MicroSPOT

In this series LEDs have beam angles of 3° with circular light spots. The residual divergence of our miniature laser modules is 1 mrad. And most important: The sample deviation is negligible. The axis





GitHub

Overview
General Instructions
Description of ROS Nodes
Additional Project Components
Future Work
External Links and References
The current software supports basic state machine operation of the spot micro robot, orientation control. My desired future goals for this project, in order of preference, are to:
1. incorporate a lidar (particularly the Slamtec RPLIDAR A1) to achieve simple 2D mapping of a room
2. develop an autonomous motion planning module to guide the robot to execute a simple task around a sensed 2D environment. For example, navigate the perimeter of a room, and dynamically avoid introduced obstacles.
See more on [github Allegro MicroSystems](#)

Sales Offices and Distributors , Allegro MicroSystems

Allegro MicroSystems partners with a worldwide network of sales offices, manufacturer's representatives, and authorized distributors to bring our

Read the Docs

Hier sollte eine Beschreibung angezeigt werden, diese Seite lässt dies jedoch nicht zu.



AE Solar

Zuverlässigkeit 30 Jahre lineare Leistungsgarantie
AE Solar SMB 60 Hot-Spot Free Solarmodul
verschattungsresistentes Solarmodul
AE Solar entwickelt und



LED Modules, Light Spot LED Lighting Modules - Mouser

LED Modules, Light Spot LED Lighting Modules are available at Mouser Electronics. Mouser offers inventory, pricing, & datasheets for LED Modules, Light Spot LED Lighting Modules.

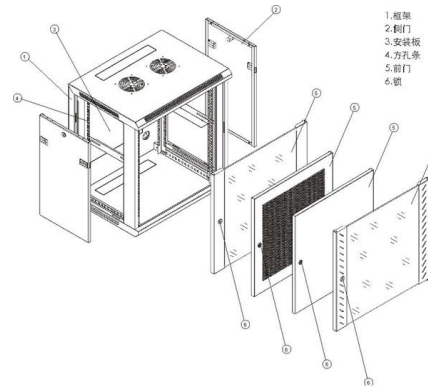

SpotMicroESP32 now with modular rear-cover and

Basically the 1.8" TFT was replaced by an 0.96" OLED now placed in the top-shell, for status reporting. I also made the rear cover modular and uploaded a template

Microdul AG

Microdul is specialized in manufacturing high-quality, miniature electronic modules and in the processing of uncased integrated circuits.



DISTRIBUTED PV GENERATION + ESS

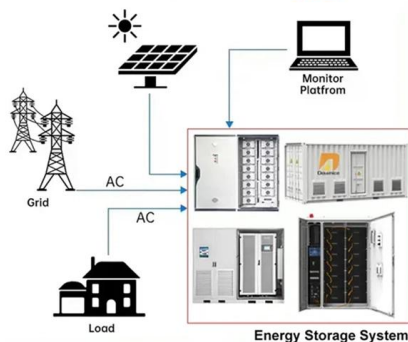

Nexperia: Global semiconductor company

Nexperia, a semiconductor manufacturer headquartered in Nijmegen, is the main partner of football club N.E.C. from Nijmegen. Today, Nexperia will be in the

Measuring devices for focus measurement



Take power of lasers: measure power density safely and reliably. The dimensions of the laser beam in focus are dependent on the raw beam quality and the imaging

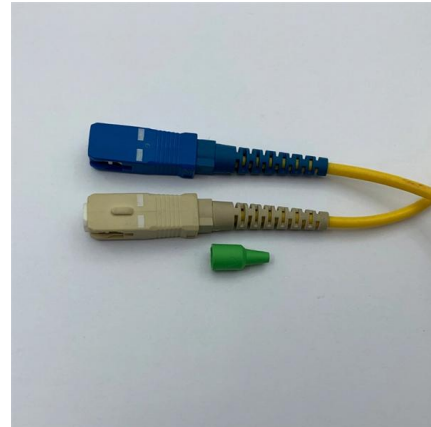

Spot Module Pro LED Array 09.0360.30 , Flos

Spot Module Pro LED Array Designed by FLOS Architectural Spotlight to be installed on Light Cut Mini system. Remote continuous current supply source not included.

Sales Offices and Distributors , Allegro MicroSystems

Allegro MicroSystems partners with a worldwide network of sales offices, manufacturer's representatives, and authorized distributors to bring our



Micro Spot 03.2301.14A , Flos

Accent lighting LED module to be installed in The Micro Running Magnet System. Built-in DC/DC electronic voltage converter. Honeycomb accessory available. Must be ordered separately. Discover



Light Shadow Mini Dots

Discover Flos Light Shadow Mini Dots - Single Spot Module. Set of 1 Spot Optic Spot 05.8400.EQ, LED - Power LED - 1.5W - 131lm - 2700K - CRI> 90 - Beam° 14.



Electronic Parts & Components, Raspberry Pi , CPC UK

With over 100,000 products, Get the best prices & fast delivery at CPC Farnell.

Contact Us

For datasheets, pricing, or custom high-speed optical interconnect solutions, please visit:
<https://syropy.com.pl>