

Which company offers the best price for busbars in Southern Europe





Which company offers the best price for busbars in Southern Europe



Busbars (Busbar)

Busbars - You find here 16 suppliers from Germany China India and Russia. Please obtain more information on spare parts, servicing, maintenance, Repair, repair or accessories directly from the

Busbars Industrial Automation - Mouser Europe

Busbars Industrial Automation are available at Mouser Electronics. Mouser offers inventory, pricing, & datasheets for Busbars Industrial Automation.

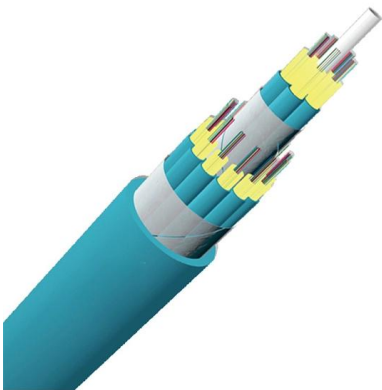

Top Busbar Manufacturers in Germany , Reliable Suppliers & Products

Find leading busbar manufacturers in Germany offering custom solutions. Need quality copper busbars for electrical systems? Connect with verified suppliers like Zisaline GmbH. Click to

Top 100 Busbar Manufacturers in 2026 , ensun

Identify and compare relevant B2B manufacturers, suppliers and retailers. Max. Legrand offers a range of busbars as part of its electrical distribution systems,



Busbars from PRV offer quality and value for money

PRV's Busbars not only offer quality and value for money, but as a company, we can meet all of your requirements in terms of Busbars, Conductors, Copper Contacts and Connections.



Global Busbar market - Size, Share, Trends, Analysis

Market Opportunities Smart Grid Infrastructure: The increasing implementation of smart grids offers significant opportunities for the busbar market. Smart grids

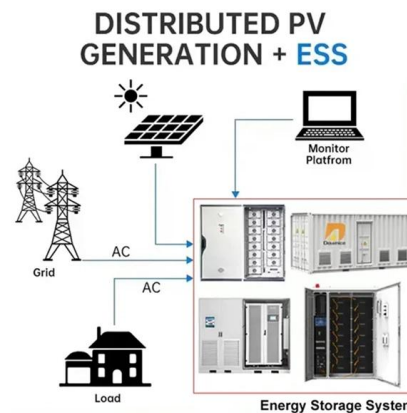

Top 7 Busbar Manufacturers: Market Share & Analyst

Busbars also known as bus bars, barra electrica, or busbar electrical systems are essential components in modern electrical distribution. Whether





Europe Busbar Systems Market Size, Growth Report 2035

Europe Busbar Systems Market growth is projected to reach USD 26500 Million, at a 17.96% CAGR by driving industry size, share, top company analysis, segments research, trends and



Busbar Market Size, Share, Growth and Forecast 2026-2034

Global busbar market size reached USD 20.3 Billion in 2025 and expected to reach USD 29.1 Billion by 2034, exhibiting a CAGR of 3.94% during 2026-2034.

Busbar Market Analysis, Size, and Forecast 2025-2029:

Busbar Market Size 2025-2029 The busbar market size is forecast to increase by USD 5.83 billion, at a CAGR of 5.5% between 2024 and 2029. The market is

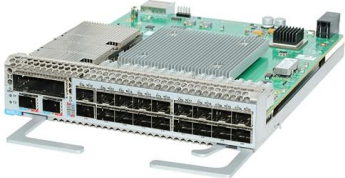

Europe Busbar Market - Size, Share, Trends, Analysis

The Europe busbar market can be segmented into several key regions, including Western Europe, Eastern Europe, and Southern Europe. Western Europe holds



The \$27.71 Billion Power Revolution: Why Busbars Are Becoming the

The market isn't without headwinds. Sharp increases in copper prices, particularly in 2024, are largely due to supply chain disruptions, increasing demand from renewable energy projects, and



busbar Manufacturer/Producer , B2B companies and suppliers

With over 30 years experience in the design, manufacture, supply, and installation of copper and aluminium AC/DC busbar and associated products, G Corner can help you no matter what your need



Europe Busbar Market Outlook, 2030

The busbar market is highly competitive, with a variety of manufacturers offering a wide range of products. Companies in the market include ABB, Siemens,



Global Busbar Market Size, Share, Growth 2032 , Research Report

Global busbar market is projected to witness a CAGR of 5.14% during the forecast period 2025-2032, growing from USD 16.33 billion in 2024 to USD 24.38 billion in 2032.





Find your busbar easily amongst the 75 products from the leading brands (CATU, Indelec, Nordel,) on DirectIndustry, the industry specialist for your professional



Europe Busbar Market Size, Share & Forecast

The Europe busbar market size reached USD 4,644.2 Million in 2025 to reach USD 7,573.0 Million by 2034 at a CAGR of 5.42% during 2026-2034.

Top Companies in Busbar Industry

The research insight on Busbar Market industry highlights the Top Companies in Busbar Industry. Get known & unknown adjacencies impacting the market for Busbar Market.

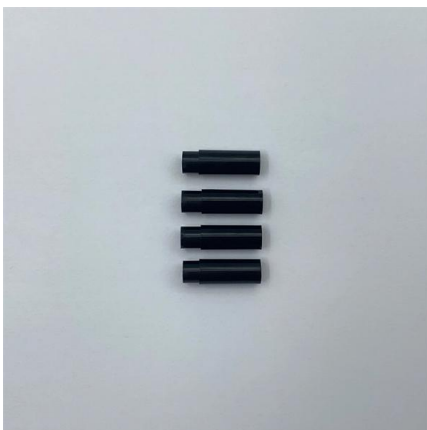
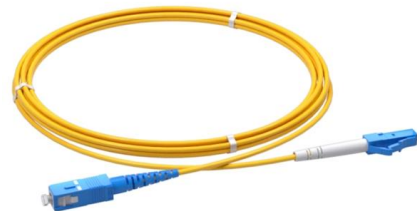

Europe Electric Vehicle Busbar Market Size, 2025-2034

The Europe electric vehicle busbar market size exceeded USD 179.8 million in 2024 and is expected to grow at a CAGR of 27.1% from 2025 to 2034, driven by



30 Busbar Manufacturers in 2026

30 Busbar Manufacturers in 2026 This section provides an overview for busbars as well as their applications and principles. Also, please take a look at the list of 30



Europe Busbar Market Size, Share, and Analysis Report

The Europe Busbar market is driven by the growing demand from 2020 to 2028. Discover Market Trends, Segmentation, and Leading Companies with Data



Electric Vehicle Busbar Market Share, Outlook 2025-2034

The electric vehicle busbar market size exceeded USD 776.1 million in 2024 and is estimated to grow at a CAGR of 20.4% from 2025 to 2034, driven by the global

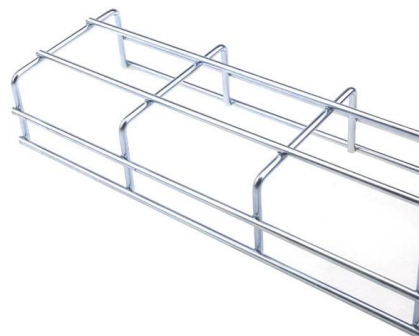

Busbars

As a long-standing busbar supplier for power transmission and industry, we guarantee the highest level of quality. Furthermore, SYKATEC is not only a



Busbars - Mouser Europe

View All Products at Mouser Electronics. Mouser Electronics is an authorised electronic component distributor offering online ordering and no minimum orders.



Top 5 Busbar Companies in the World

Siemens is a German multinational conglomerate corporation and the most significant industrial manufacturing company in Europe with branch offices abroad. The principal divisions of the

Busbars

As one of Europe's largest busbar processors, we offer our customers first-class solutions made of copper, aluminum, and Cuponal. With



30 Busbar Manufacturers in 2026

This section provides an overview for busbars as well as their applications and principles. Also, please take a look at the list of 30 busbar manufacturers and



Business Standard

Hier sollte eine Beschreibung angezeigt werden, diese Seite lässt dies jedoch nicht zu.

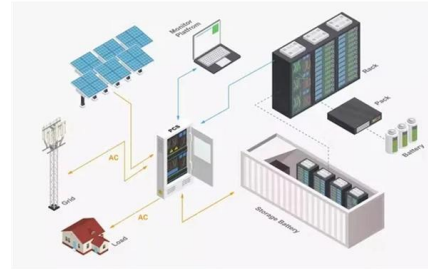

Busbar Products Pricing Guide: Understanding Costs

This guide offers a detailed busbar pricing guide for electrical contractors, explores what affects pricing, and provides strategies to get the best value busbar



Contact Us

For datasheets, pricing, or custom high-speed optical interconnect solutions, please visit:
<https://syropy.com.pl>